

RACE  RESULT

www.raceresult.com



DATA SHEET

Print Products



Index

General	3
Bibs (all sizes)	4
Road Bike Plate	14
Flyers/Certificates (all sizes)	15
Stickers (all sizes)	16
Triathlon Sticker Set	17
Seatpost Sticker	18
Seatpost Sticker with Transponder	19
RACE RESULT Triathlon-Tag	20
Envelopes (C4)	21
Triathlon Multi-Sheet	22



General

Layouts:

You have the following options:

- Use our standard layouts from the online shop (please let us know which in the remarks).
- Send us your logos, with instructions as to where to place them in the remarks.
- Send us your own layout, ready to go. Please make sure they follow these specifications:

Technical specifications:

Color space: CMYK (no spot colors)
Profile: ISO Coated v2
Resolution: 300 dpi
File format: PDF (with embedded fonts or vectorized texts)
AI/EPS (send fonts and images)
JPG/PNG/PSD/TIFF
INDD (send fonts and images)

Personalization data:

Send us the event ID or an excel file.

Layout templates:

Templates for InDesign, Photoshop and Illustrator are available for download in this document for every product. Just click on the download link  on the correct page.

RACE RESULT URL:

Please note that the URL "www.raceresult.com" is printed by default on all bibs we produce.

If you do not want the URL to appear on your bibs, you must write it explicitly in the comments when placing your order.

Standard fonts:

Bibs: Helvetica Neue LT Com 97 Blk
Road Bike Plate: Tungsten Semibold
Personalisation: Arial bold

If you would like another font on your bibs, please write it down in the description of your layout, and upload the font file in .otf or .ttf format.

DO NOT include the following elements in your layout:

- Place holder for the bib number
- Place holder for personalization (e. g. firstname)
- Punch holes
- Rounded corners
- Outline of the end format

The RACE RESULT Team will place these for you.

Special Perforation/Die-Cut

New orders:

Select the corresponding option under "Special Perforation/Press Cut" when ordering your race numbers through the online shop.

Costs: USD 500.00

Reordering an existing cutting die:

State your wish in the "Remarks" field, citing the old order-number.

The following costs will be added to your order by our team:

- A one-time setup fee of USD 90.00
- USD 0.04 per race number

Note that in both cases the production time will increase.

Production Note

An offset of up to 2 mm (1/16") can occur during cutting of the final format, also differences of up to 1 mm (1/32") can occur during printing. The trim is used to negate the differences from cutting and printing.

Important Notice Regarding the Production Process:

You will receive a preview for all printed products (except for regular bibs and RACE RESULT bibs), that you need to approve for printing. It is not possible to change anything after you have approved the preview.

Contact

For any questions, contact us via email at shop@raceresult.com.

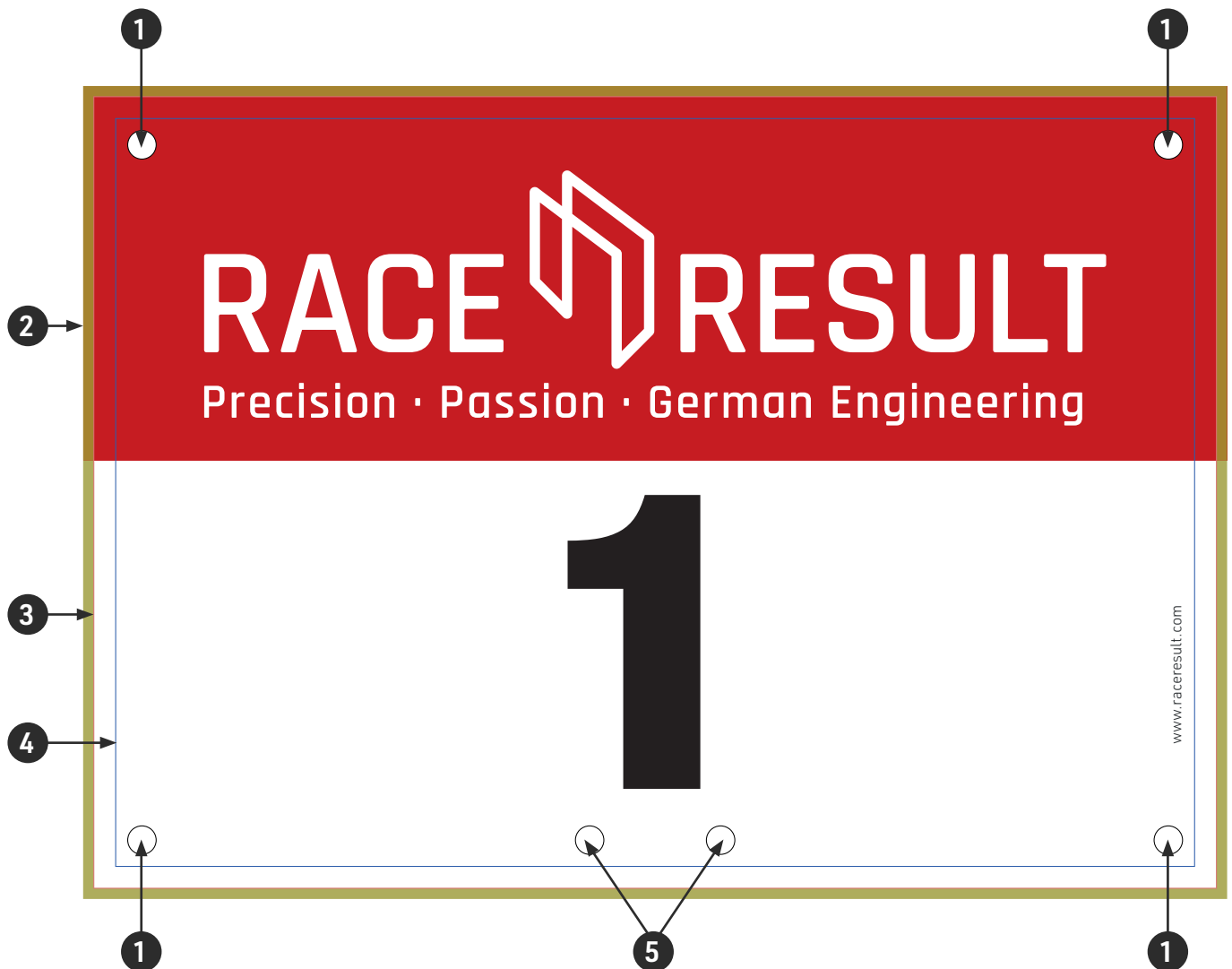

1 Punch holes Tyvek Bibs:	Ø 5,5 mm / 0.22" Position: 9 mm / 0.35" from the top/bottom and from the sides (from the center of the hole to the edge of the end format)
2 Total size:	A5 = 214 x 152 mm / 8.42 x 5.98" A6 = 152 x 109 mm / 5.98 x 4.29" Bleed: 2 mm / 0.08" (orange part)
3 Size (pink line):	A5 = 210 x 148 mm / 8.26 x 5.82" A6 = 148 x 105 mm / 5.8 x 4.1"
4 Safety margin (blue line):	4 mm / 0.16"
5 Punch holes MTB:	Ø 5,5 mm / 0.22" Position: 90 mm / 3.54" from left/right and 9 mm / 0.35" from the bottom (measured from the center of the hole to the edge of the end format)

Please also read the text on page 3.

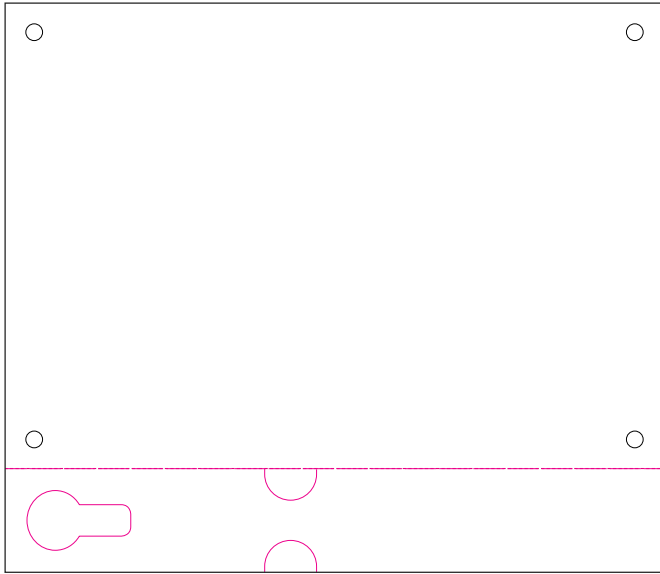

A5 Bib with tear-off bag tag

Bib size: 210 x 148 mm / 8.27 x 5.83"

Tag size: 210 x 33 mm / 8.27 x 1.30"

Total size (with bleed): 214 x 185 mm / 8.43 x 7.28"

Please follow the same instructions regarding holes, margins and bleed as for the bib on page 4:

Bleed: 2 mm / 0.08"

Safety margin: 4 mm / 0.16"

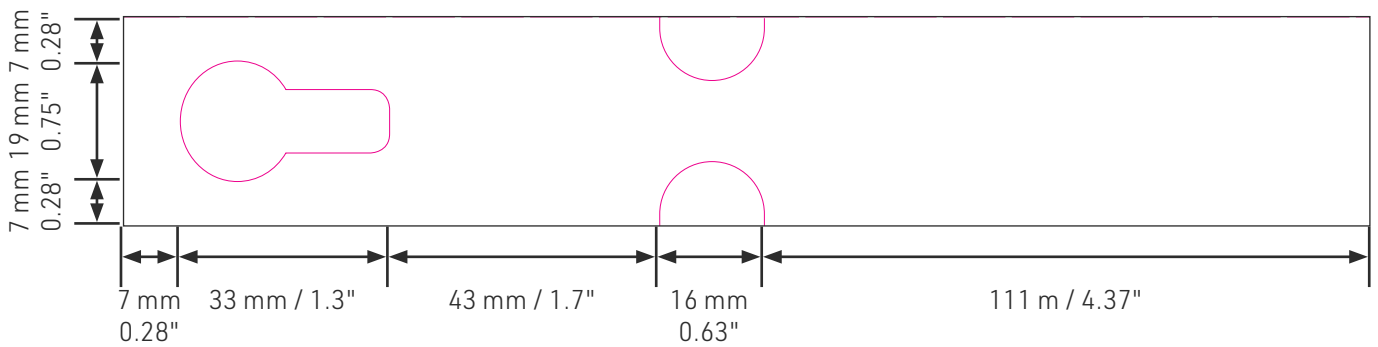

Please also read the text on page 3.

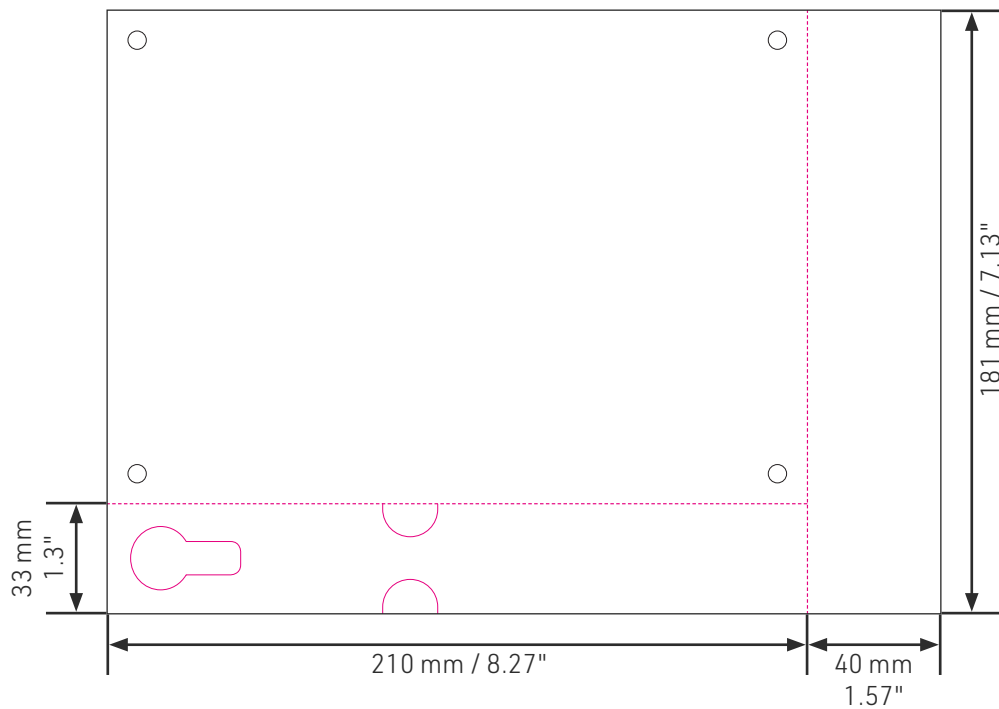

A5 Bib with tear-off bag tag + 1 tear-off tag

Bib size: 210 x 148 mm / 8.27 x 5.83"
Bag Tag size: 210 x 33 mm / 8.27 x 1.30"
Tag size right: 40 x 181 mm / 1.57 x 7.13"

Total size (with bleed): 254 x 185 mm / 10 x 7.28"

Please follow the same instructions regarding holes, margins and bleed as for the bib on page 4:
Bleed: 2 mm / 0.08"
Safety margin: 4 mm / 0.16"

Please also read the text on page 3.

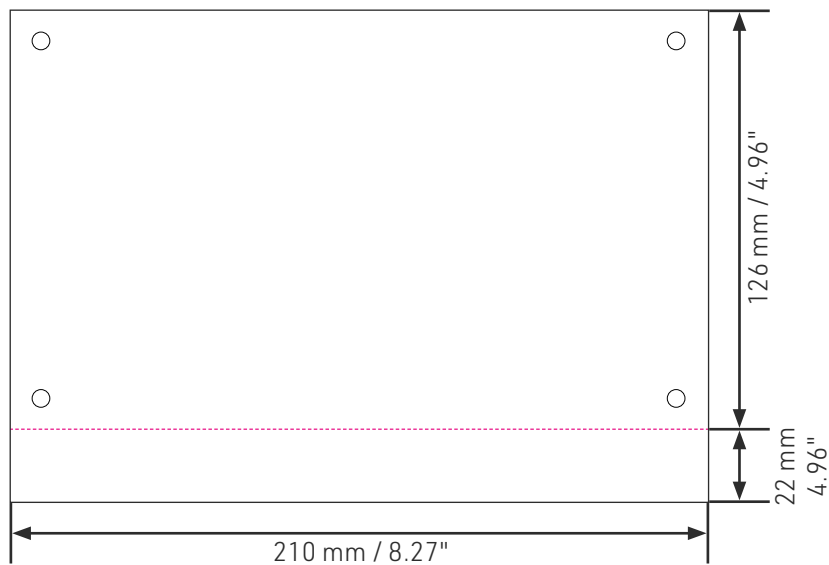

A5 Bib incl. 1 tear-off tag at the bottom

Bib size: 210 x 126 mm / 8.27 x 4.96"

Tag size: 210 x 22 mm / 8.27 x 0.87"

Total size (with bleed): 214 x 152 mm / 8.43 x 5.98"

Please follow the same instructions regarding holes, margins and bleed as for the bib on page 4:

Bleed: 2 mm / 0.08"

Safety margin: 4 mm / 0.16"

Please also read the text on page 3.

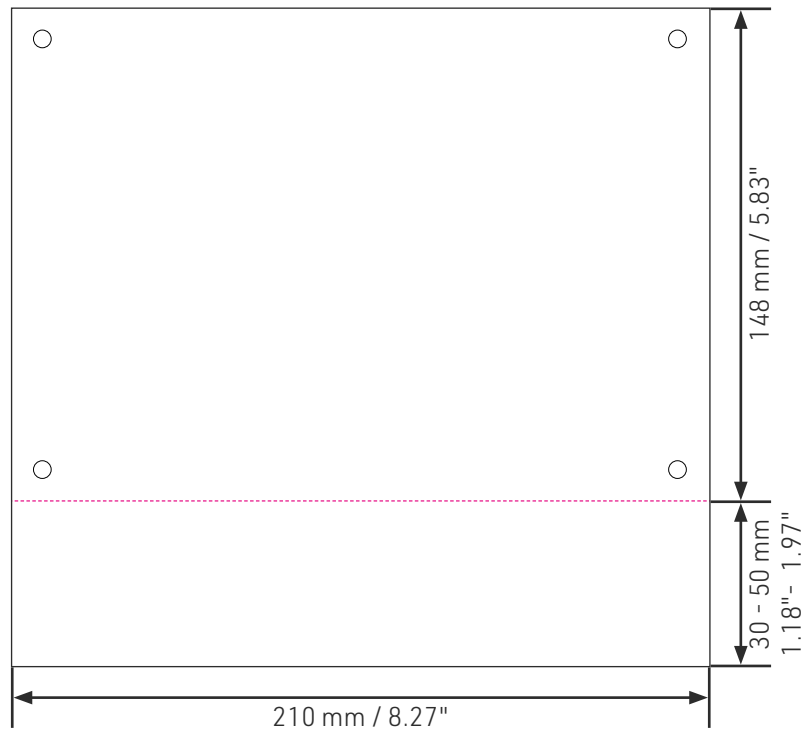

A5 Bib with 1 tear-off tag at the bottom

Bib size: 210 x 148 mm / 8.27 x 5.83"

Tag size: 210 x 30 mm / 1.18" (max. 50 mm / 1.97")

Total size (with bleed): 214 x 182 mm / 8.27 x 7.17"

Please follow the same instructions regarding holes, margins and bleed as for the bib on page 4:

Bleed: 2 mm / 0.08"

Safety margin: 4 mm / 0.16"

Please also read the text on page 3.

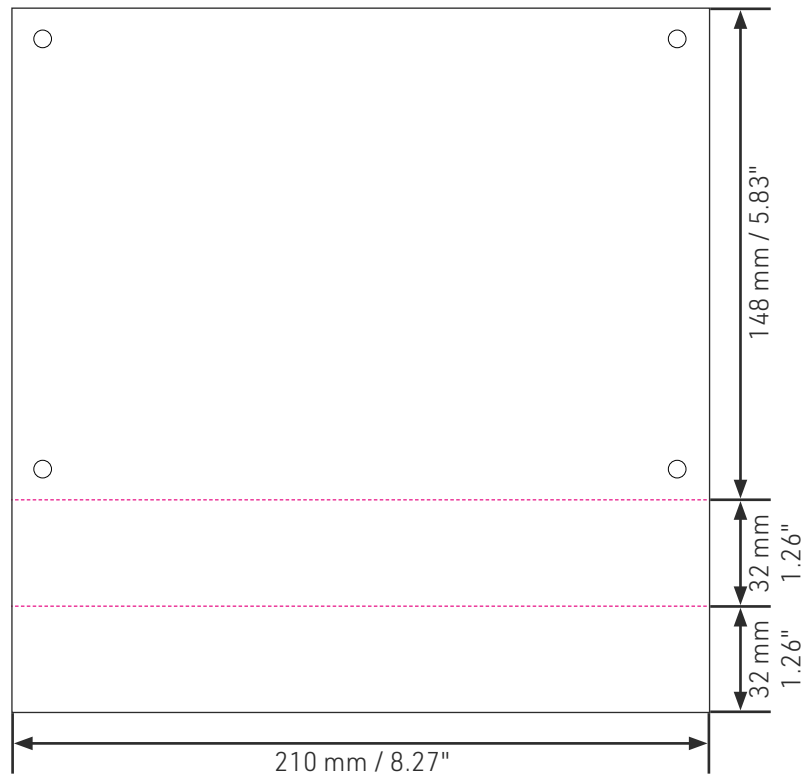

A5 Bib with 2 tear-off tags at the bottom

Bib size: 210 x 148 mm / 8.27 x 5.83"

Upper tag size: 210 x 32 mm / 8.27 x 1.26"

Lower tag size: 210 x 32 mm / 8.27 x 1.26"

Total size (with bleed): 214 x 216 mm / 8.27 x 8.50"

Please follow the same instructions regarding holes, margins and bleed as for the bib on page 4:

Bleed: 2 mm / 0.08"

Safety margin: 4 mm / 0.16"

Please also read the text on page 3.

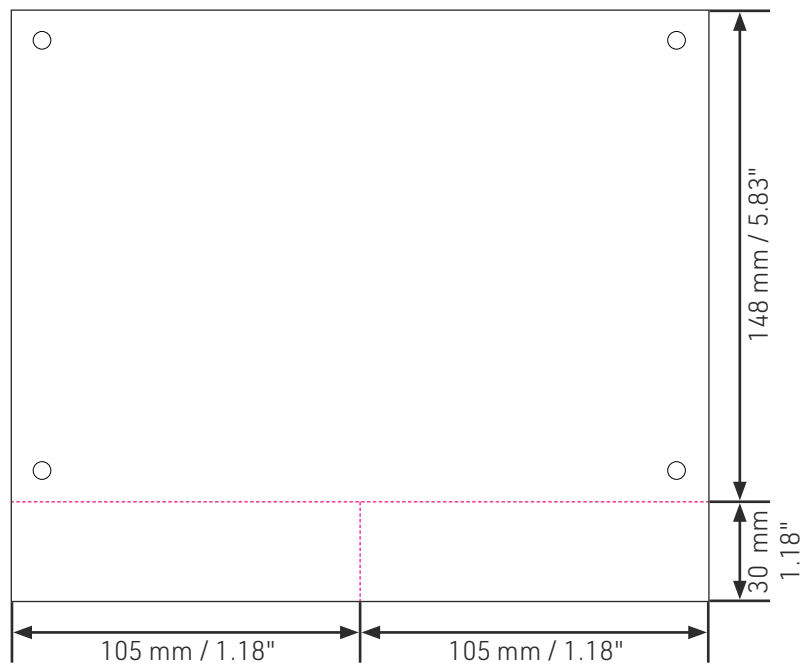

A5 Bib with 2 tear-off tags at the bottom side by side

Bib size: 210 x 148 mm / 8.27 x 5.83"
Left/right tag size: 105 x 30 mm / 4.13 x 1.18"

Total size (with bleed): 214 x 182 mm / 8.27 x 7.17"

Please follow the same instructions regarding holes,
margins and bleed as for the bib on page 4:
Bleed: 2 mm / 0.08"
Safety margin: 4 mm / 0.16"

Please also read the text on page 3.

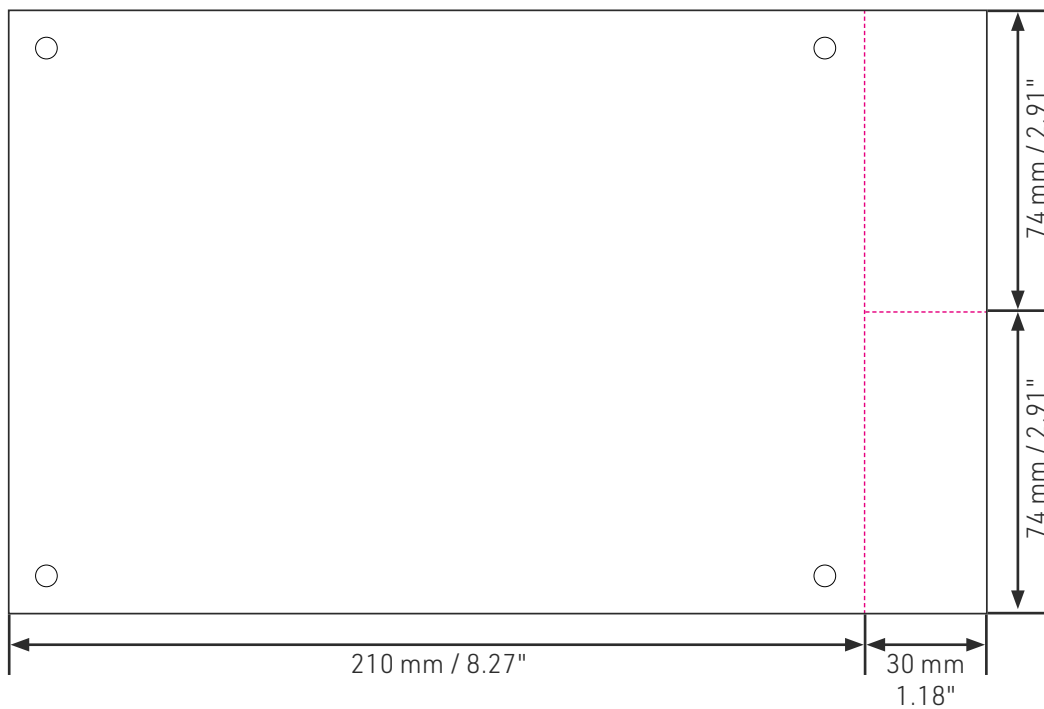

A5 Bib with 2 tear-off tags on the right

Bib size: 210 x 148 mm / 8.27 x 5.83"

Tag size (each): 30 x 74 mm / 1.18 x 2.91"

Total size (with bleed): 244 x 152 mm / 9.60 x 5.98"

Please follow the same instructions regarding holes, margins and bleed as for the bib on page 4:
Bleed: 2 mm / 0.08"
Safety margin: 4 mm / 0.16"

Please also read the text on page 3.

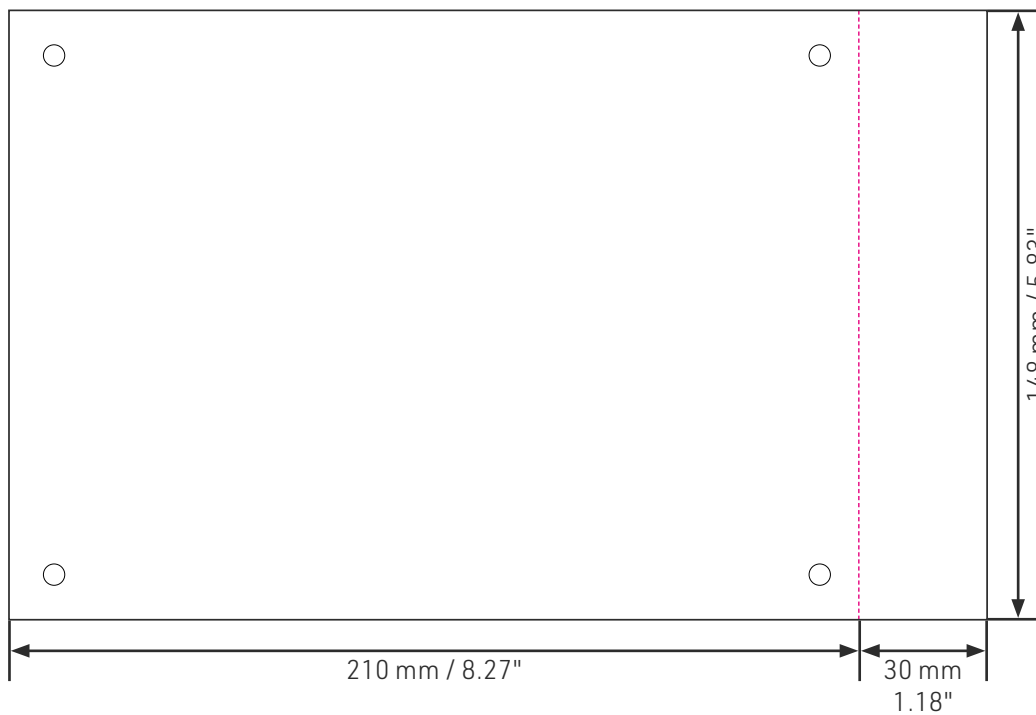

A5 Bib with 1 tear-off tag on the right

Bib size: 210 x 148 mm / 8.27 x 5.83"

Tag size: 34 x 148 mm / 1.34 x 5.83"

Total size (with bleed): 244 x 152 mm / 9.60 x 5.98"

Please follow the same instructions regarding holes, margins and bleed as for the bib on page 4:

Bleed: 2 mm / 0.08"

Safety margin: 4 mm / 0.16"

Please also read the text on page 3.

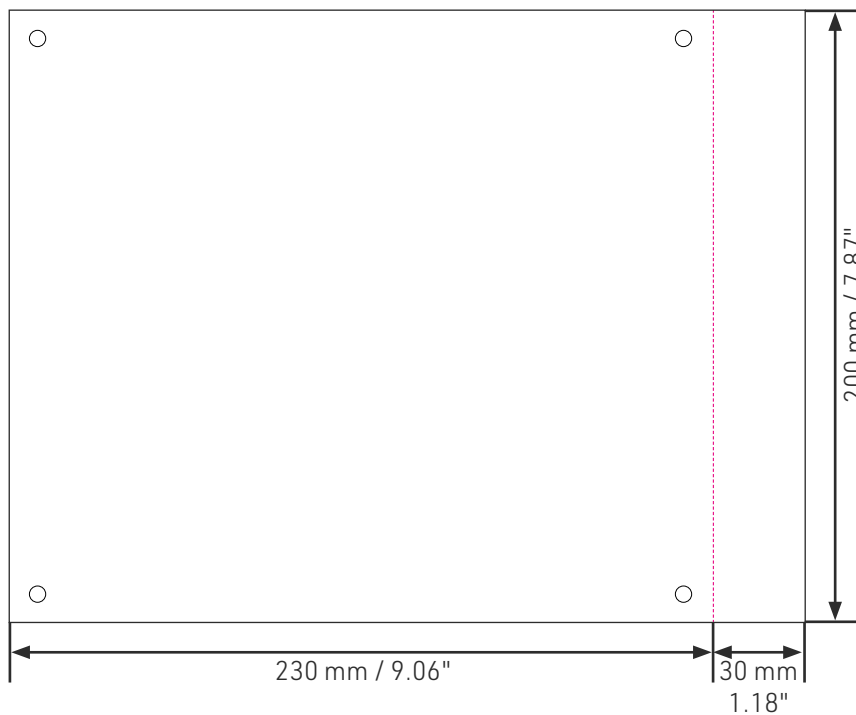

Bib Special Size with 1 tear-off tag on the right

Bib size: 230 x 200 mm / 9.06 x 7.87"
Tag size: 30 x 200 mm / 1.18 x 7.87"

Total size (with bleed): 264 x 204 mm / 10.39 x 8.03"

Please follow the same instructions regarding holes, margins and bleed as for the bib on page 4:
Bleed: 2 mm / 0.08"
Safety margin: 4 mm / 0.16"

Please also read the text on page 3.

Road Bike Plate

[↓ Template](#)



Plate size: 130 x 90 mm / 5.12 x 3.54"
Total size: 134 x 94 mm / 5.28 x 3.70"

Punch holes diameter: 5,5 mm / 0.22"

Please be aware that you need to create 2 layouts,
as the front and the back side are inverted.

Please follow the same instructions regarding margins
and bleed as for the bib on page 4:

Bleed: 2 mm / 0.08"

Safety margin: 4 mm / 0.16"

Please also read the text on page 3.

Flyers/Certificates (all sizes)

[↓ Template](#)



	Size:	Total size:	Bleed:	Safety margin:
A4	210 x 297 mm / 8.27 x 11.69"	214 x 301 mm / 8.43 x 11.85"	2 mm / 0.08"	4 mm / 0.16"
A5	148 x 210 mm / 5.83 x 8.27"	152 x 214 mm / 5.98 x 8.43"	2 mm / 0.08"	4 mm / 0.16"
A6	105 x 148 mm / 4.13 x 5.83"	107 x 150 mm / 4.21 x 5.90"	1 mm / 0.04"	4 mm / 0.16"

Please make sure, that you have read all notes regarding margins and bleed as for the bib on page 4 and in the general section.

Please also read the text on page 3.

Stickers (all sizes)



Minimum size: 60 x 30 mm / 2.36 x 1.18"

Minimum total size: 64 x 34 mm / 2.52 x 1.34"

Please follow the same instructions regarding margins and bleed as for the bib on page 4:

Bleed: 2 mm / 0.08"

Safety margin: 4 mm / 0.16"

Please also read the text on page 3.

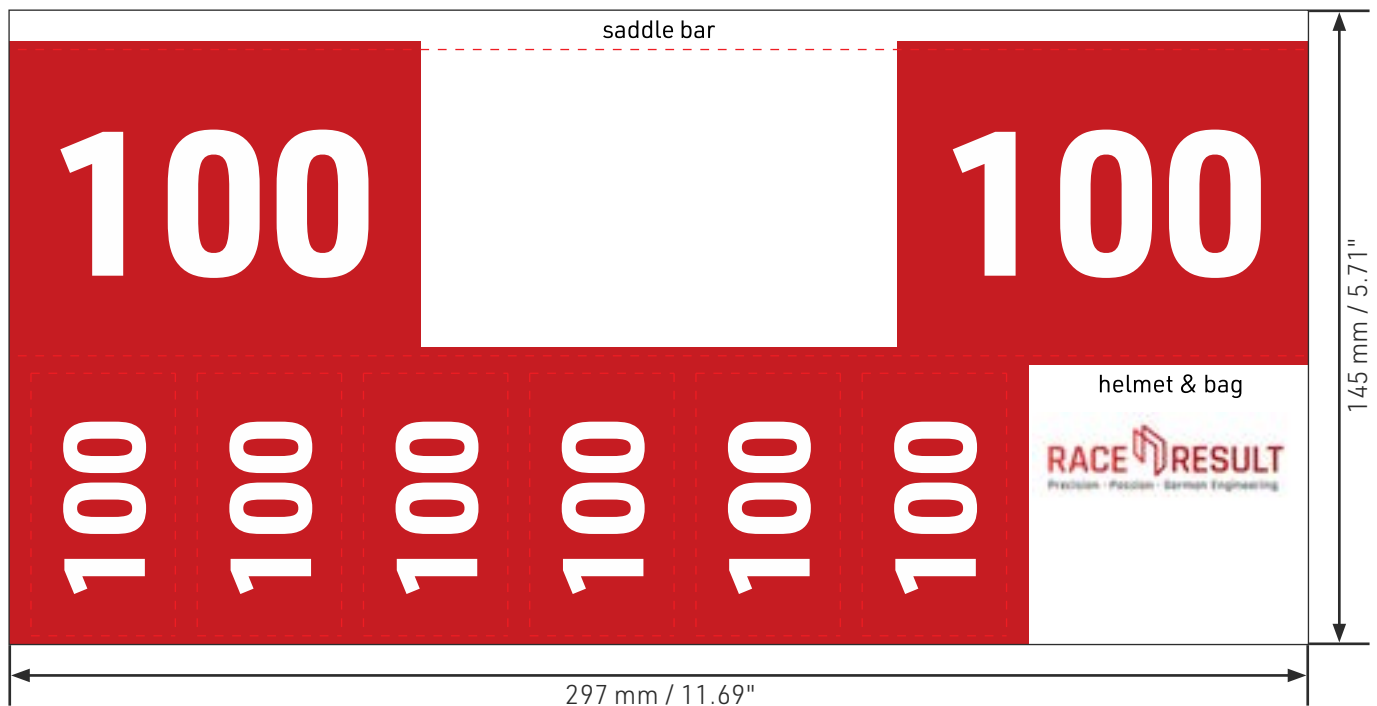

Total size: 301 x 145 mm / 11.85 x 5.71"

You will find the exact dimensions of each element in the InDesign, Photoshop and Illustrator templates.

Please follow the same instructions regarding margins and bleed as for the bib on page 4:

Bleed: 2 mm / 0.08"

Safety margin: 4 mm / 0.16"

Please also read the text on page 3.

Seatpost Sticker

 [Template](#)

full color

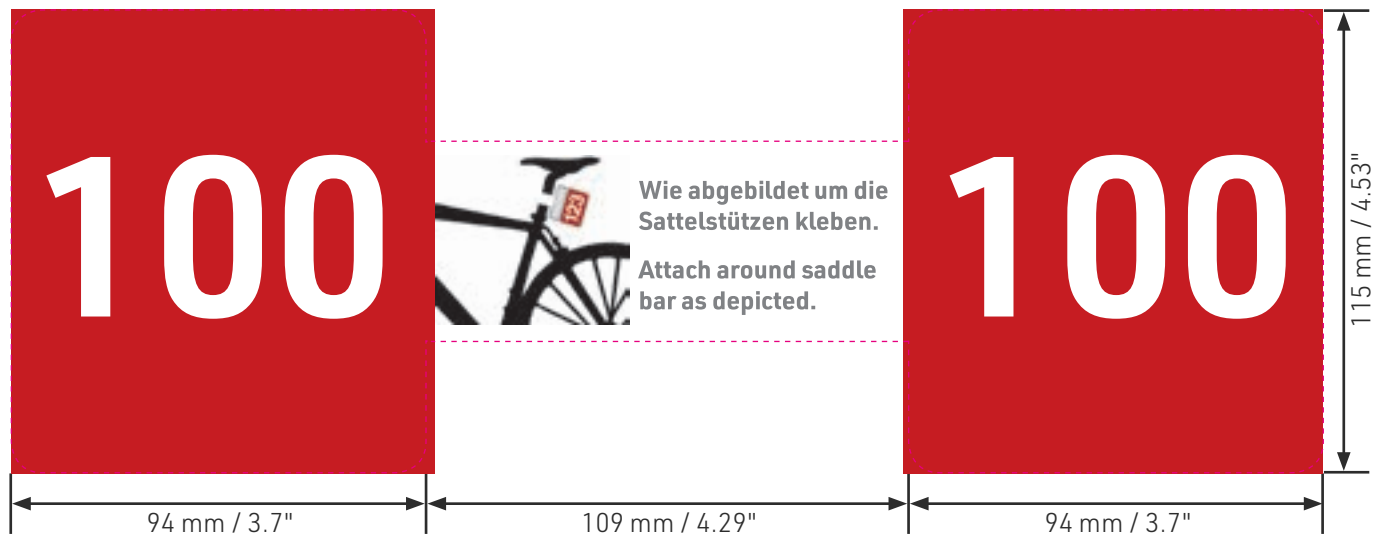

b/w



Size: 297 x 105 mm / 11.69 x 4.13"
Total size: 301 x 119 mm / 11.85 x 4.69"

Please follow the same instructions regarding margins and bleed as for the bib on page 4:

Bleed: 2 mm / 0.08"

Safety margin: 4 mm / 0.16"

Please also read the text on page 3.

Seatpost Sticker with Transponder [↓ Template](#)

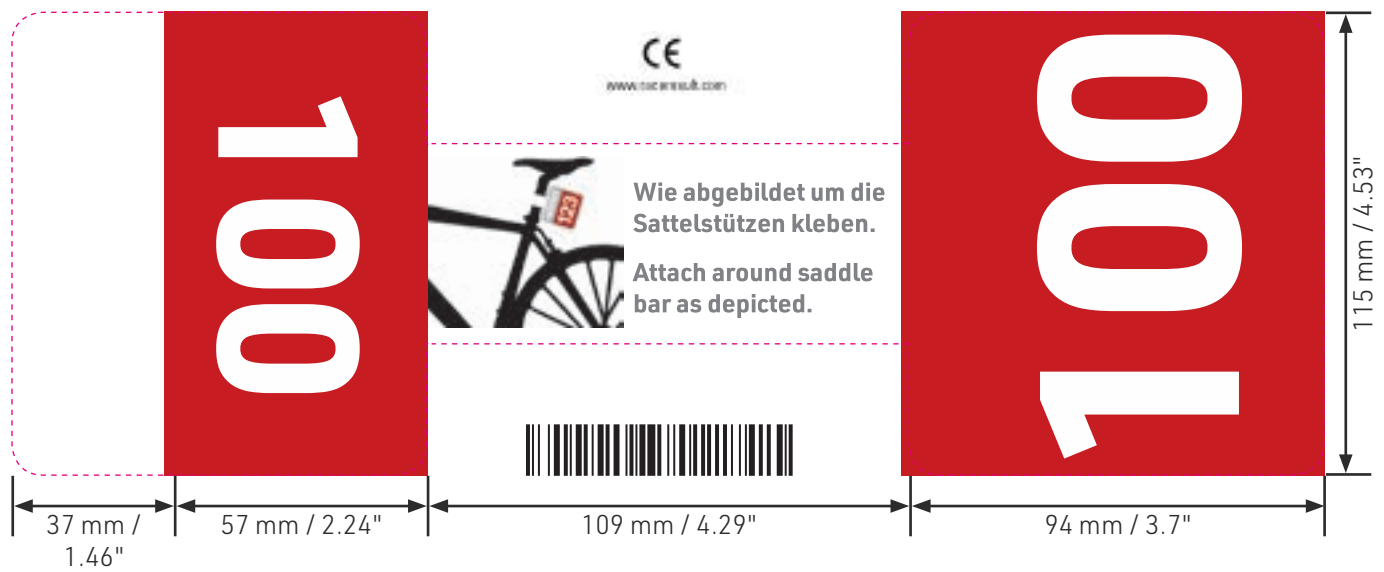

Size: 297 x 105 mm / 11.69 x 4.13"

Total size: 301 x 119 mm / 11.85 x 4.69"

The red area can be customized.

Please follow the same instructions regarding margins and bleed as for the bib on page 4:

Bleed: 2 mm / 0.08"

Safety margin: 4 mm / 0.16"

Please also read the text on page 3.

RACE RESULT Triathlon-Tag

[Template](#)

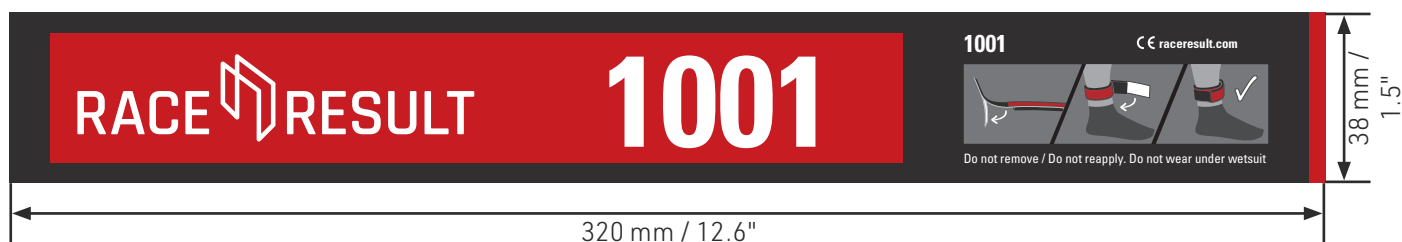
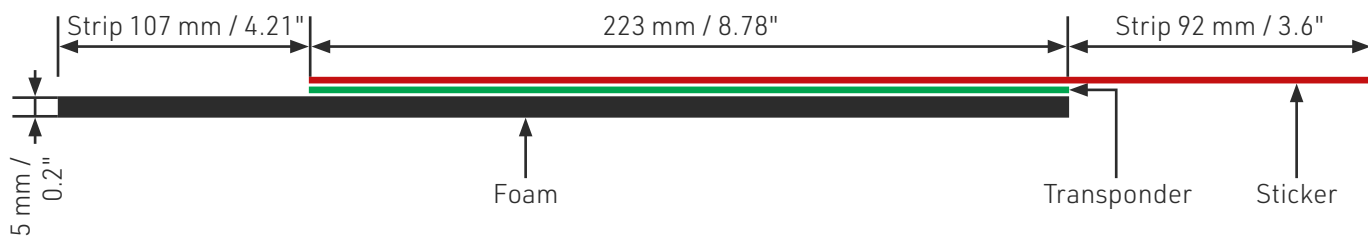

Size: 422 x 38 mm / 16.61 x 1.5"

Total size: 210 x 32 mm / 8.27 x 1.25"

(Bleed or cutting marks are not necessary)

Please also read the text on page 3.

Envelopes (C4)

[↓ Template](#)

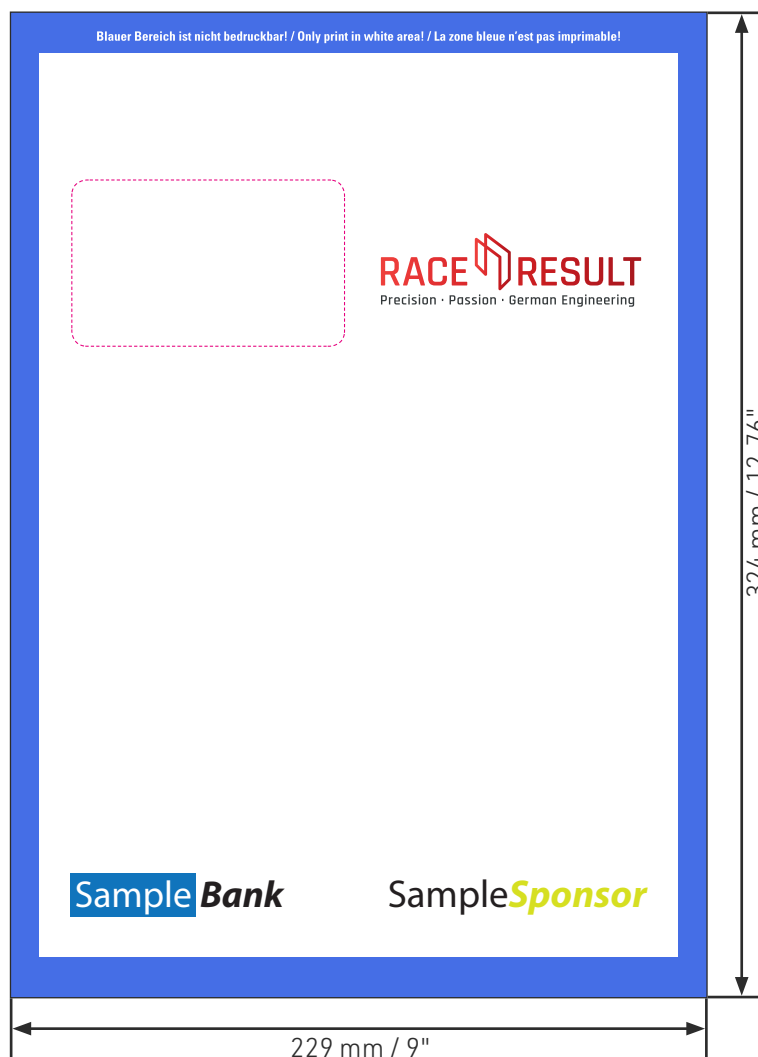

	Size:	Total size:	Bleed:	Safety margin:
C4	229 x 324 mm / 9 x 12.76"	210 x 297 mm / 8,27 x 11,69"	0 mm / 0"	0 mm / 0"

Envelopes can only be printed in the DIN A4 (210 x 297 mm / 8,27 x 11,69") format. Please send the file in this size. A borderless print is not possible.

Please also read the text on page 3.

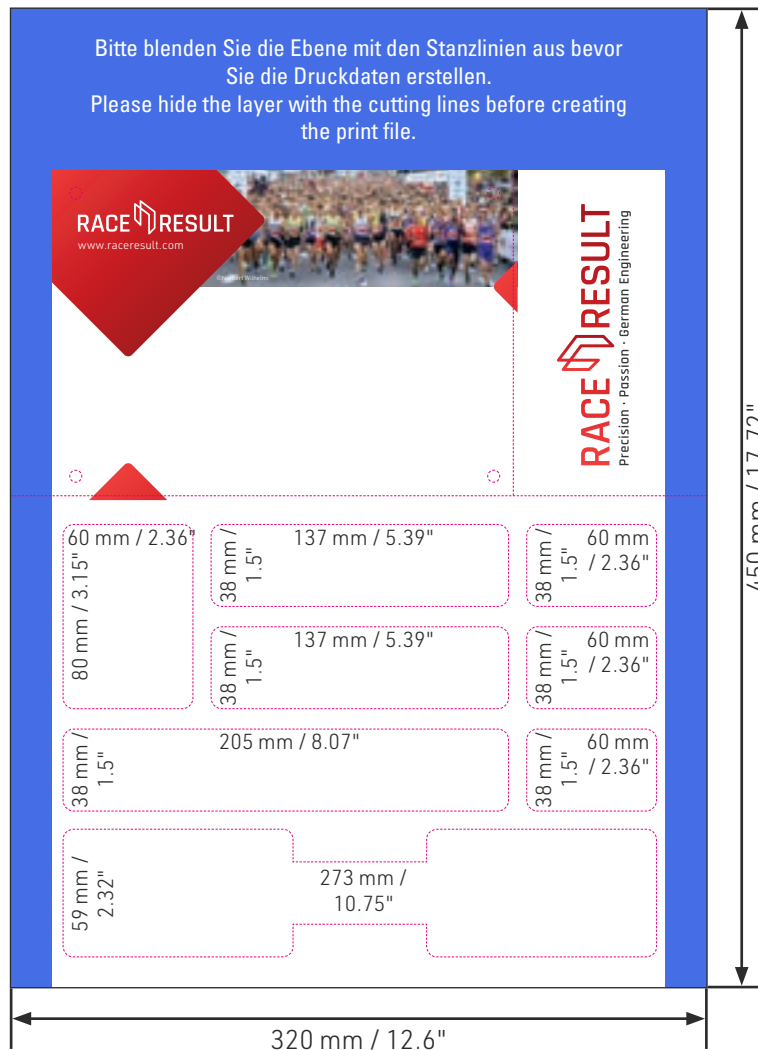

Total size: 320 x 450 mm / 12.6 x 17.72"

You will find the exact dimensions of each element in the InDesign, Photoshop and Illustrator templates.

Please follow the same instructions regarding margins and bleed as for the bib on page 4:

Bleed: 2 mm / 0.08"

Safety margin: 4 mm / 0.16"

Please also read the text on page 3.

Headquarters Deutschland

race result AG

Joseph-von-Fraunhofer-Straße 11
76327 Pfinztal
Germany

Phone +49 (721) 961 409 01
shop@raceresult.com
www.raceresult.com